

型号：201544

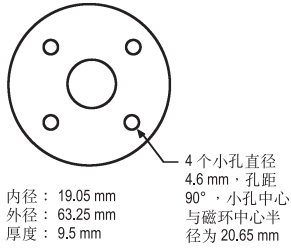

型号：201553

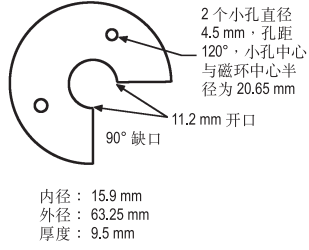

型号：401467

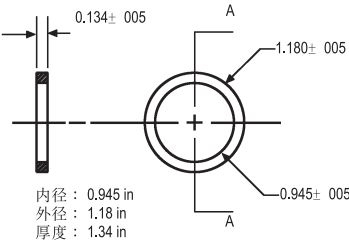

型号：401468

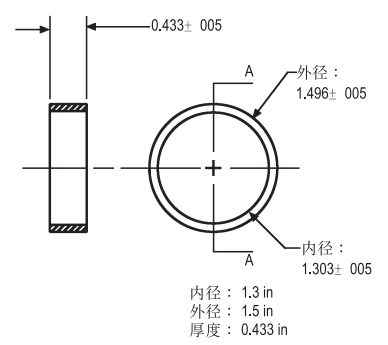

型号：251416

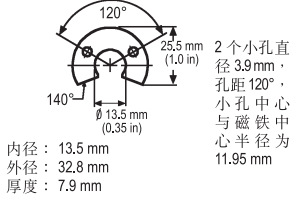

型号：201542 (订货标准)

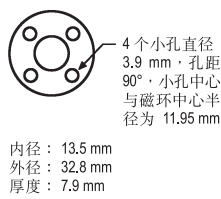

型号：400633 (非导磁垫片)

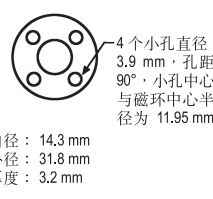

型号：251447

浮子磁铁 (液压油应用)

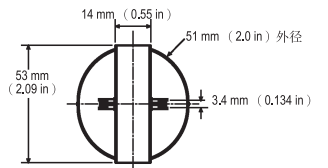

比重最大：0.70
压力最大：870 PSI
(只适用于 "H" 型传感器外壳，应用于测量液压油或水)

型号：400533

(行程 ≤ 3050 mm)



型号：401032

(行程 ≤ 1520 mm)



型号：251298-2

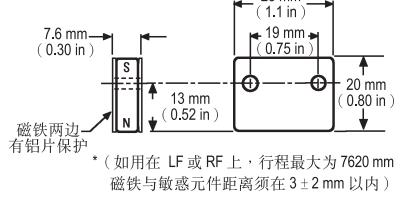

V 型滑块

型号：252111-1

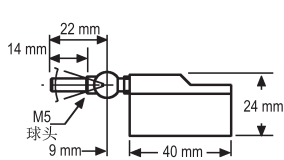

S 型滑块

型号：252110-1

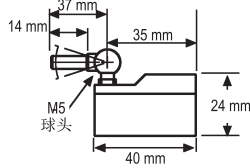

LP 用滑块

型号：252052 (10-32 螺纹)
型号：252053 (M5 螺纹)

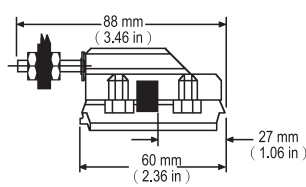

LP 用滑块

型号：252092 (压铸机专用)

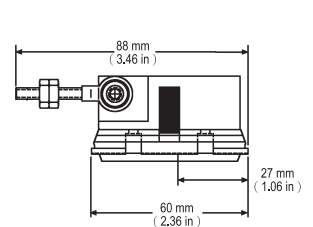

磁铁型号	传感器类别									
	圆管外壳						铝成型外壳			
	RH	RF	LH	LF	LD	T2	RP	LP	LS	EP
201554	•	•	•	•	•	•				
201553	•	•	•	•	•	•				
251416	•	•					•			•
201542	•	•	•	•	•	•				
400533	•	•	•	•	•	•				
401032	•	•	•	•	•	•				
251298-2	•	•	•	•	•	•	•	•	•	•
401467		•		•						
401468		•		•						
252111-1						•	•		•	•
252110-1							•		•	•
252052								•		
252053								•		
252092								•		
251447 (浮子)	•		•		•	•				